

**ALIAS** 

DESIGN SECURITY DOORS



## INDICE

### **GRATE ANTIEFFRAZIONE IN CLASSE 3 - CLASS 3 ANTI BURGLARY SECURITY GATES**

DEFENDER / DEFENDER pag. 5

### **PRODOTTI SPECIALI - SPECIAL PRODUCTS**

FALCON / FALCON pag. 22

DEFENDER A 3 ANTE / 3 LEAVES DEFENDER pag. 27

---

### **GRATE ANTIEFFRAZIONE IN CLASSE 2 - CLASS 2 ANTI BURGLARY SECURITY GATES**

FIGHTER / FIGHTER pag. 33



**CON DEFENDER, FALCON E FIGHTER,**  
NATURALE COMPLETAMENTO DELLA SICUREZZA FIRMATA  
ALIAS, PROTEGGI L'INTERO PERIMETRO DELLA TUA CASA.

SICUREZZA, INNOVAZIONE, PERFORMANCE, DESIGN NON  
SOLO PER LA PORTA D'INGRESSO, MA ANCHE PER TUTTI  
GLI ALTRI VARCHI, COME FINESTRE E PORTEFINESTRE.

ALIAS, CHE FIN DAI SUOI ESORDI HA FATTO DELLA CON-  
TINUA RICERCA LA PROPRIA MISSIONE, CONIUGANDO LE  
ABILITÀ DELLE MAESTRANZE ARTIGIANALI CON I PRO-  
CESSI INDUSTRIALI, E' OGGI GARANZIA D'INVIOLABILITÀ  
DELLA CASA A 360°.

---

DEFENDER, FALCON AND FIGHTER COMPLETE THE SAFETY PRODUCTS FAMILY SIGNED ALIAS AND CONTRIBUTE TO  
PROTECT THE ENTIRE PERIMETER OF YOUR HOME.

SAFETY, INNOVATION, PERFORMANCE AND DESIGN NOT ONLY FOR THE ENTRANCE DOOR BUT ALSO FOR ALL OTHER  
OPENING SUCH AS WINDOWS.

SINCE ITS BEGINNING, THE MISSION OF ALIAS ITSELF, HAS ALWAYS BEEN FOCUSED ON CONTINUOUS RESEARCH. THE  
ABILITY AND SKILLS OF CRAFTSMEN COMBINED WITH INDUSTRIAL PROCESSES TOTALLY SECURE YOUR HOME

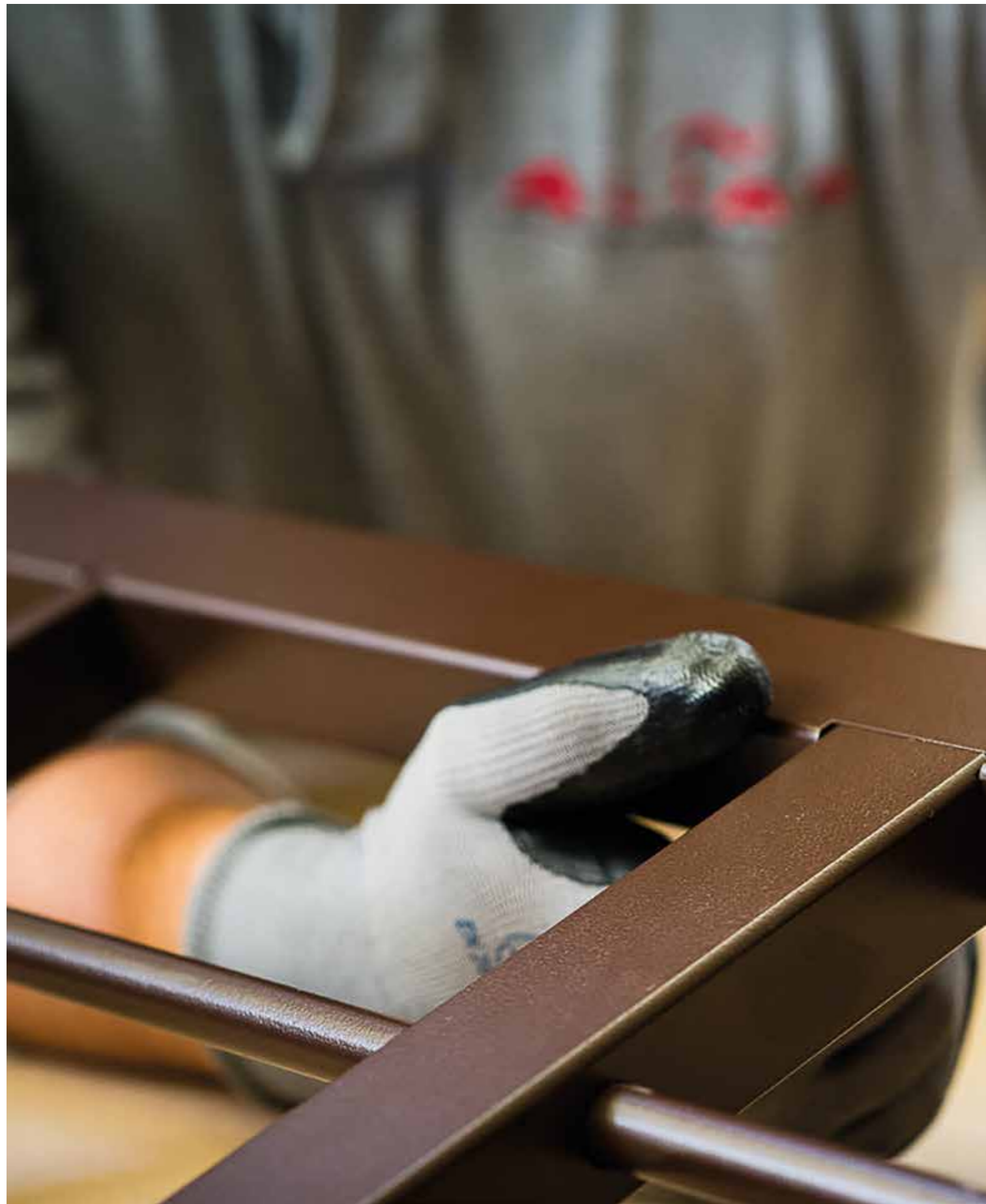

# DEFENDER

## CLASSE 3



LA PROTEZIONE DELLA TUA CASA È UN BISOGNO PRIMARIO. SICUREZZA, TRANQUILLITÀ E RISERVATEZZA SONO ELEMENTI INDISPENSABILI.

SENTIRSI BENE E PROTETTI IN CASA PROPRIA MIGLIORA LA QUALITÀ DELLA TUA VITA.

---

Home protection is a primary need. Security, privacy, tranquility are basic elements. Feeling good and protected at home is part your quality life.

# DEFENDER

ALIAS OFFRE LA CERTEZZA DI SOLUZIONI INNOVATIVE CON UN SISTEMA COMPLETO PER LA SICUREZZA DELLA TUA CASA CHE SI SVILUPPA IN FUNZIONE DELLE TUE NECESSITÀ, OFFRENDOTI COMPETENZA E PLURIENNALE ESPERIENZA NEL CAMPO DELLA SICUREZZA ABITATIVA. IL NOSTRO PERSONALE ALTAMENTE QUALIFICATO TROVERÀ, ALL'INTERNO DI UN'AMPIA GAMMA DI PRODOTTI, LE MIGLIORI SOLUZIONI AI TUOI BISOGNI E ALLE TUE ESIGENZE.

---

Alias offers innovative solutions for a house protection's complete system. According to customer's need, Alias can propose its long experience in security home field that starts from security door and today arrives to the protection of all external openings. Alias's experienced team will be able to find the most suitable solutions for your needs and problem among the wide range of products.





# DEFENDER

LE GRATE **DEFENDER** SONO STATE PENSATE PER PROTEGGERE ABBINANDO LA RESISTENZA ALL'EFFRAZIONE CERTIFICATA IN **CLASSE 3**, ALL'ARMONIA ED ELEGANZA CHE DA SEMPRE CONTRADDISTINGUONO I PRODOTTI ALIAS.

---

DEFENDER grates have been projected to protect your home combining certified anti-burglary class 3 with the harmony and style as all Alias products.





# DEFENDER

SONO DISPONIBILI DIVERSI MODELLI MODULABILI CON VARI DECORI E ACCESSORI TECNICI PER SODDISFARE OGNI PIÙ PARTICOLARE ESIGENZA. LE COLORAZIONI DISPONIBILI SONO FRA OLTRE 30 FINITURE MARTELLATE E METALLIZZATE E TUTTE QUELLE DELLA TABELLA RAL.

---

Different models are available and they can be customized with different finishing and technical options to satisfy all the requests. The available colors are 30 hammering and metalized finishing and all available RAL colors.





# DEFENDER

CERNIERE ASCOMPARSADISERIEEDUPLICEPOSSIBILITÀ  
DI APERTURA: PARZIALE ALL'INTERNO DELL'AMBIENTE,  
TOTALE ALL'ESTERNO COMPLETAMENTE A RIDOSSO  
DEL SERRAMENTO E DELLA PERSIANA GRAZIE AD UN  
PRATICO SNODO DI DUE LUNGHEZZE DIFFERENTI.

---

Hidden Hinges as standard and double opening possibility:  
inside it can be opened partially whereas outside it can be  
opened totally next to window and the blind thanks to an  
easy junction of 2 different lengths.





# DEFENDER

GRAZIE AL TAGLIO LASER, NEL MIGLIOR STILE ALIAS, LA LINEA È PRECISA E RIGOROSA E SI CONTRADDISTINGUE PER LA TOTALE ASSENZA DI SALDATURE A VISTA. TUTTI I PRODOTTI SONO PREDISPOSTI PER ACCOGLIERE UN SISTEMA ANTIFURTO WIRELESS.



---

Thank to laser cutting, as all Alias products, the line is strict and precise and it is featured by invisible welding. All the grates are set for the installation of a wireless alarm system.

# MODELLI

CON BARRE PIENE  
TONDE O QUADRE,  
A SCELTA

MODELS WITH FULL, ROUND OR  
SQUARE BARS, AT YOUR CHOICE

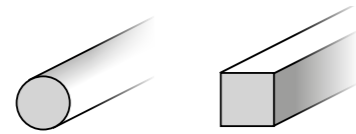

## GRUPPO SERRATURA

LOCK GROUP

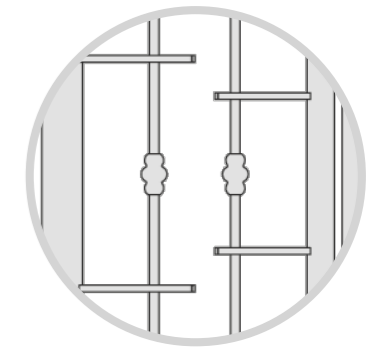
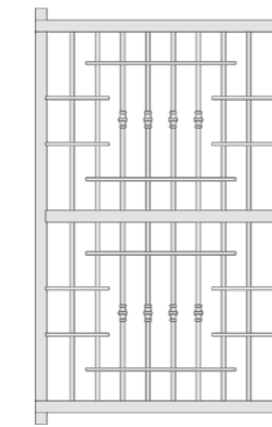
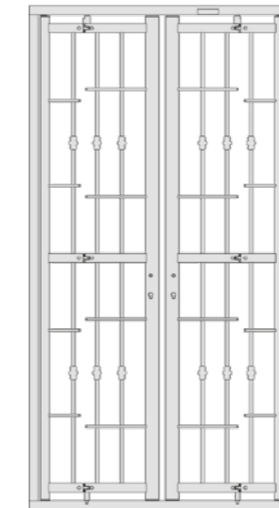
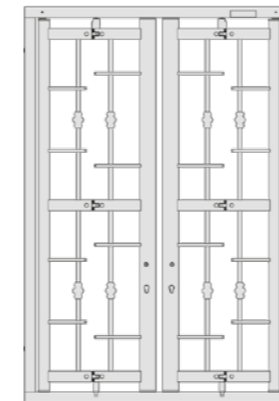

DEFENDER  
D300



DEFENDER  
D100

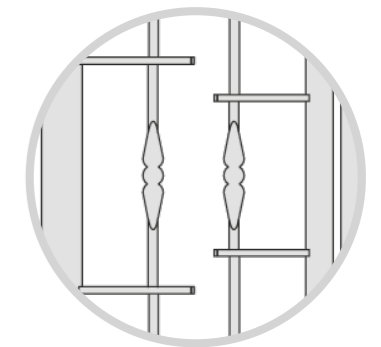
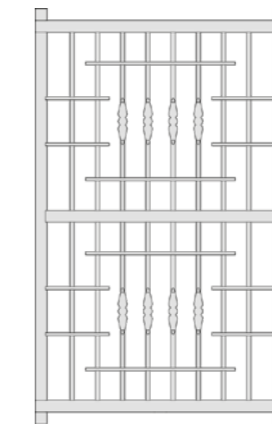
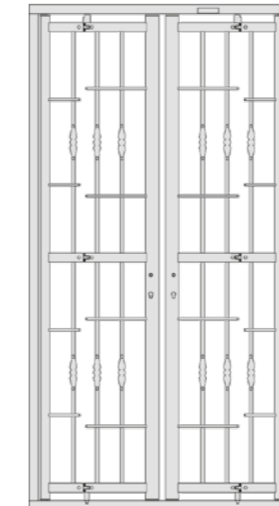
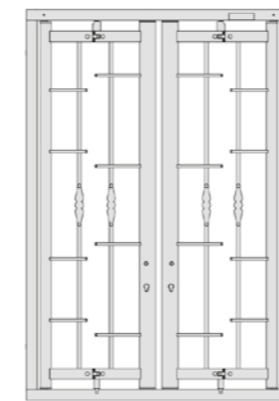
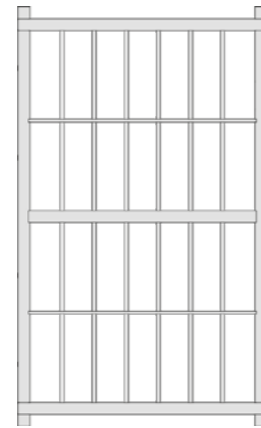

DEFENDER  
D400

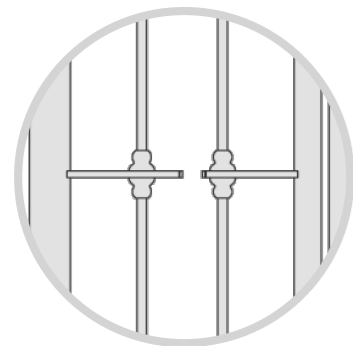

DEFENDER  
D200

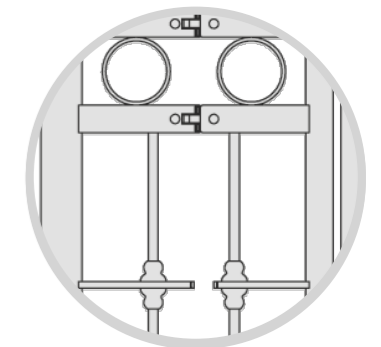
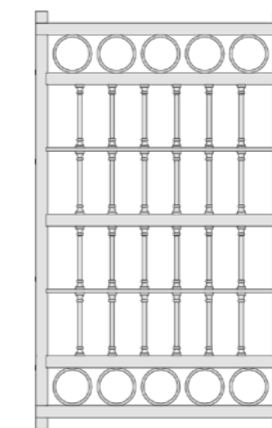
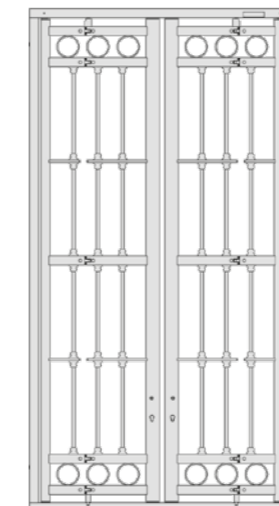
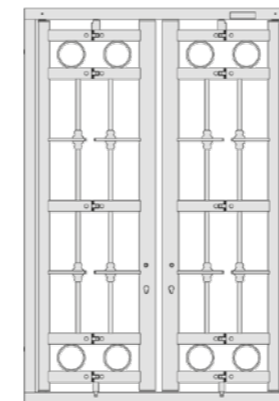
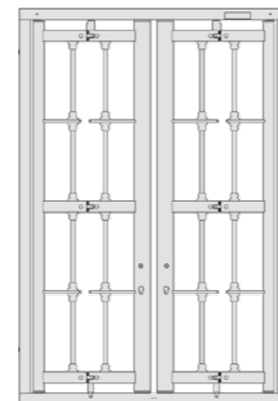
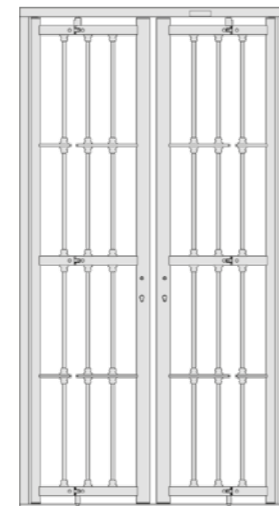
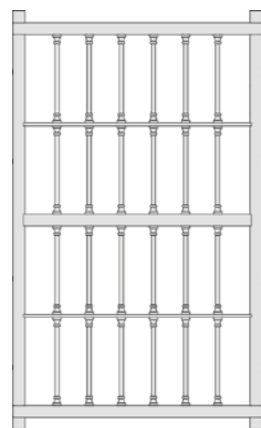

DEFENDER  
D500



# PRODOTTI SPECIALI

CLASSE 3



FALCON,  
LATO ESTERNO  
FALCON  
EXTERNAL SIDE

# FALCON

QUESTA NUOVA SOLUZIONE E' CARATTERIZZATA DA UN DESIGN PIU' TRADIZIONALE, SEMPRE RAFFINATO. LE LINEE, PULITE, SONO PERSONALIZZABILI SU DISEGNO.

---

This new solution is characterized by a more traditional design; by refined and clean lines that can always be customized at your choice

FALCON,  
LATO INTERNO  
FALCON  
INTERNAL SIDE



# FALCON

FALCON É REALIZZATA DA UN UNICO FOGLIO DI ACCIAIO DELLO SPESSORE DI 4 MM TAGLIATO AL LASER. É, QUINDI, TOTALMENTE PRIVA DI ANTIESTETICI SEGNI DI SALDATURA.



---

FALCON is made with a laser cut 4 mm sheet of steel. It is therefore completely free of welding marks

# DEFENDER A TRE ANTE

## 3 LEAVES DEFENDER



UNA SOLUZIONE SPECIALE PENSATA PER LA SICUREZZA DELLE GRANDI APERTURE.  
GRATE A 3 ANTE DOTATE DI APERTURE CON SNODI, FISSE O A LIBRO. QUALE PREFERITE?

---

A special solution designed for the safety of large openings.

3 Leaves gates, fixed or with joints or folding opening system. Which one do you prefer?



# DEFENDER A TRE ANTE CON APERTURA A LIBRO

3 LEAVES DEFENDER WITH  
FOLDING OPENING SYSTEM

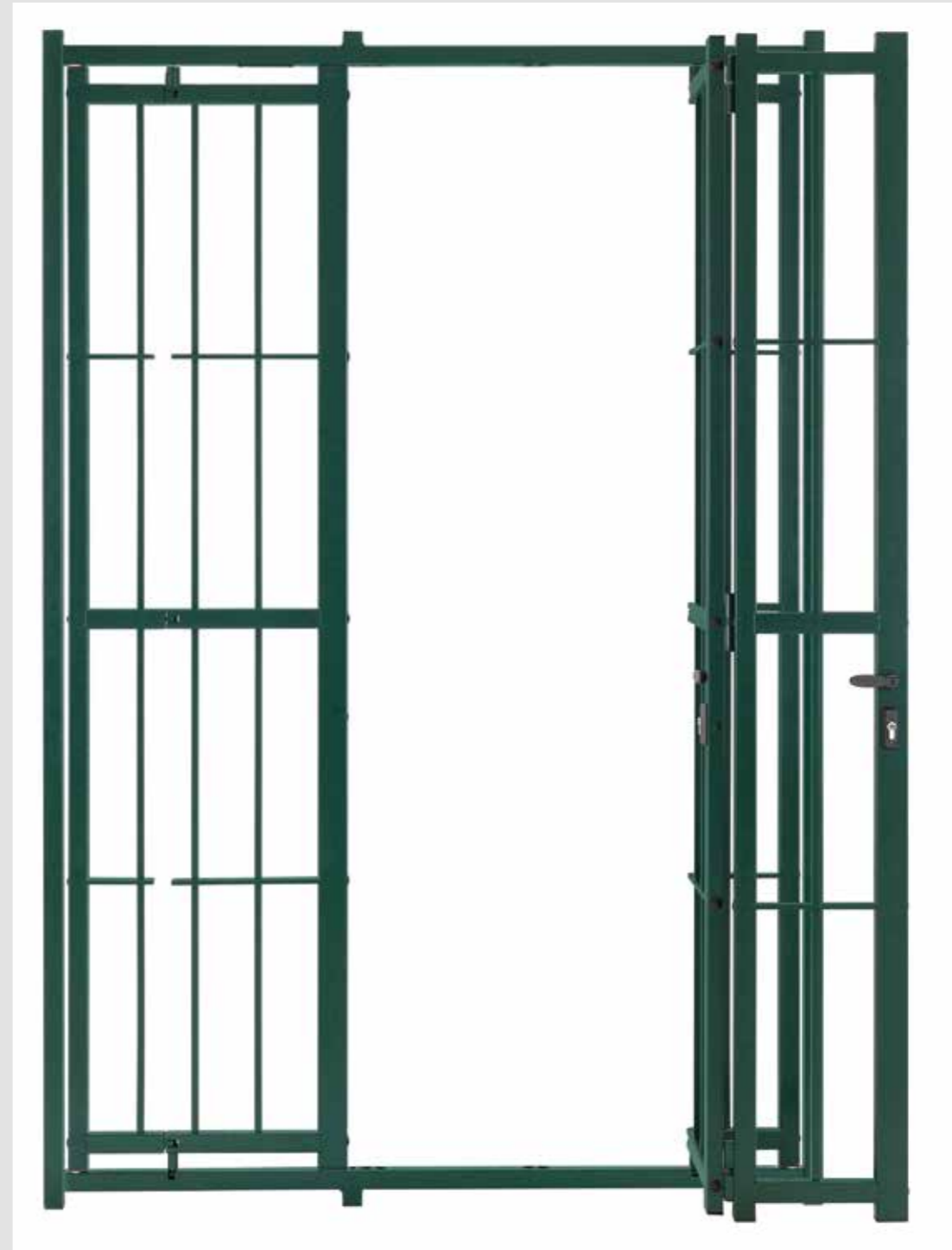



LE CERNIERE A VISTA CONSENTONO UN'APERTURA TOTALE A 180°. IL TAGLIO LASER, COME PER TUTTE LE LINEE DELLE GRATE DI SICUREZZA FIRMATE ALIAS, DONA PRECISIONE ED ELEGANZA ALLE LINEE

External hinges allow a total 180 ° opening. The laser cutting, for the whole range of safety gates signed by alias, gives precision and elegance to the lines.



## DEFENDER A TRE ANTE CON APERTURA A LIBRO

3 LEAVES DEFENDER WITH  
FOLDING OPENING SYSTEM

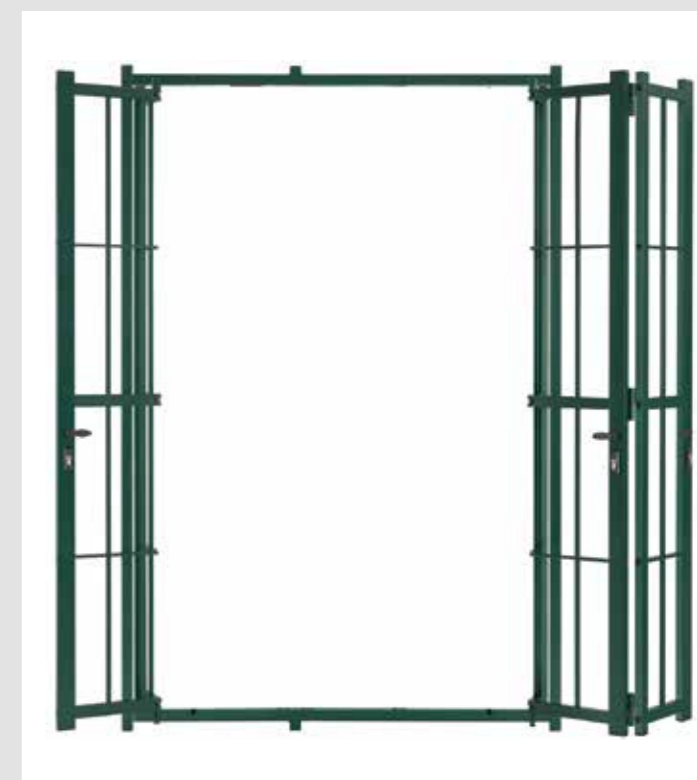



# FIGHTER

## CLASSE 2





---

FIGHTER is the new line of class 2 anti burglary security gates signed by alias. According to the models, it can be equipped by either 2 or 4 round horizontal crosspieces or with decorative studs.

The unmistakable file rouge common to all alias products is the precision of the lines due to the laser cutting that ensures the total absence of welding marks

FIGHTER E' LA NUOVA LINEA DI GRATE ANTIEFFRAZIONE IN CLASSE 2 FIRMATA ALIAS. A SECONDA DEI MODELLI, PUO' AVERE 2 O 4 TRAVERSI ORIZZONTALI TONDI PIUTTOSTO CHE ESSERE DOTATA DI BORCHIE DECORATIVE. INCONFONDIBILE RESTA IL FILE ROUGE CHE ACCOMUNA TUTTE LE LINEE DI PRODOTTO ALIAS: LINEE PRECISE GRAZIE ANCHE AL TAGLIO LASER CHE GARANTISCE LA TOTALE ASSENZA DI SALDATURE A VISTA.

# FIGHTER 100

FIGHTER 100,  
LATO ESTERNO  
FIGHTER 100  
EXTERNAL SIDE

PARTICOLARE DEL TRAVERSO TONDO  
Detail of the round crosspiece



FIGHTER 100,  
LATO INTERNO  
FIGHTER 100  
INTERNAL SIDE



OPZIONE, SU RICHIESTA,  
"SNODO FIGHTER" A VISTA E PERNO  
A SFERA CHE SOSTITUISCE I DUE  
SNODI IN CASO DI PERSIANA APERTA

Optional external "flexo joint" and ball pin that  
replaces the two joints in case of open shutter

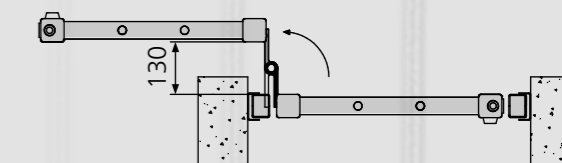



# FIGHTER 200

PARTICOLARE DEL TRAVERSO TONDO E DECORO  
Detail of the round crosspiece and of the decoration



FIGHTER 200,  
LATO ESTERNO

FIGHTER 200  
EXTERNAL SIDE

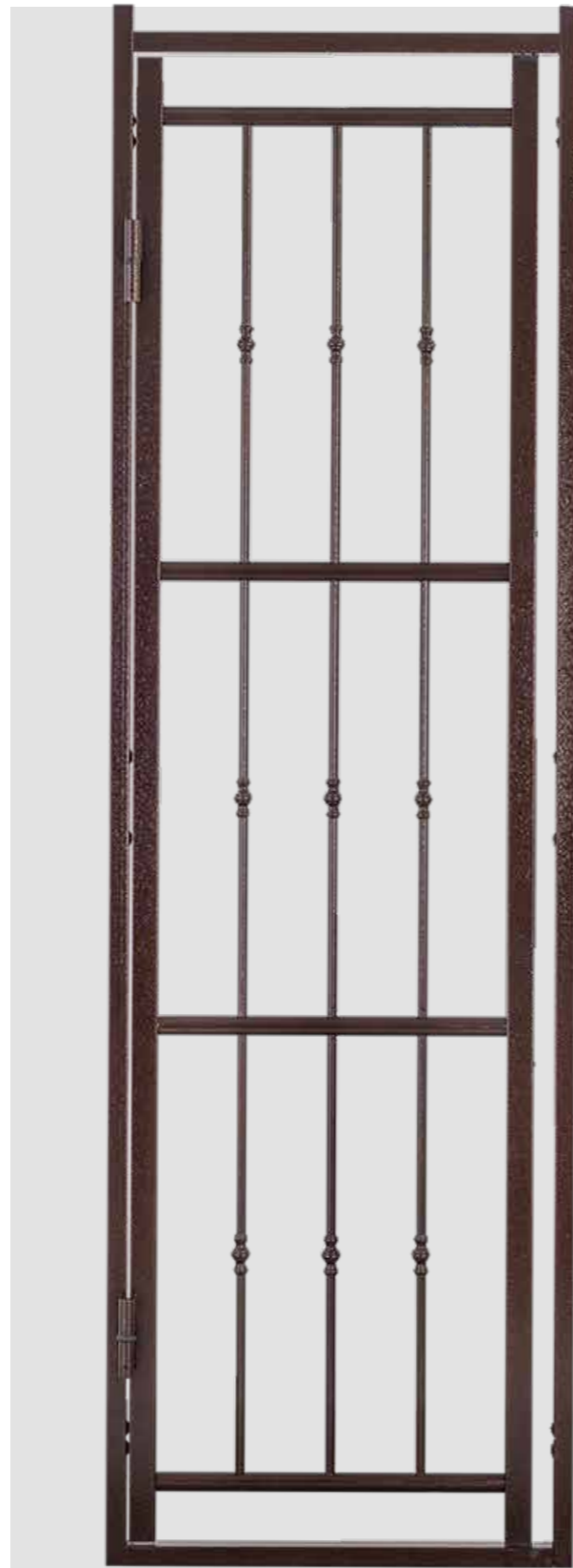

FIGHTER 200,  
LATO INTERNO

FIGHTER 200  
INTERNAL SIDE



OPZIONE, SU RICHIESTA,  
"SNODO FIGHTER" A VISTA E PERNO  
A SFERA CHE SOSTITUISCE I DUE  
SNODI IN CASO DI PERSIANA APERTA

Optional external "flexo joint" and ball pin that  
replaces the two joints in case of open shutter

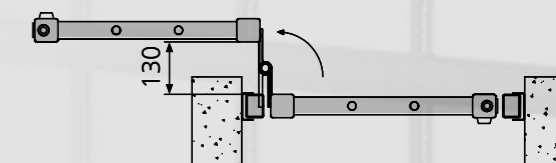

TUTTI I MODELLI FIGHTER APRIBILI POSSONO ESSERE DOTATI DI UN SISTEMA (OPZIONE SU RICHIESTA SENZA SOVRAPPREZZO) CHE SOSTITUISCE I DUE SNODI IN CASO DI PERSIANA APRIBILE.

E' POSSIBILE SCEGLIERE TRA PIU' DI 30 FINITURE MARTELLATE E METALIZZATE, OLTRE CHE TRA TUTTE QUELLE PRESENTI NELLA TABELLA RAL.



All openable fighter models can be equipped with a system (option on request without extra charge) that replaces the two joints in case of openable shutters.

More than 30 hammered and metallic finishings available, in addition to all color range of the ral table.

# MODELLI

MODELLI CON 2 O 4  
BARRE ORIZZONTALI  
PIENE E TONDE CON  
O SENZA DECORI

MODELS WITH 2 OR 4 FULL AND  
ROUND HORIZONTAL BARS WITH OR  
WITHOUT DECORATIONS

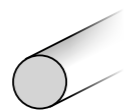

## PARTICOLARE DEI TRAVERSI TONDI

DETAIL OF THE ROUND CROSSPIECE

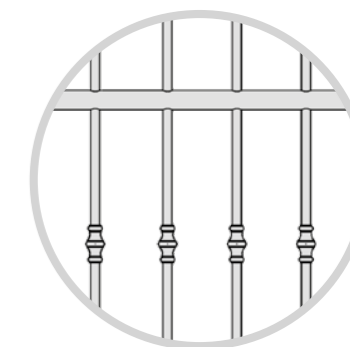
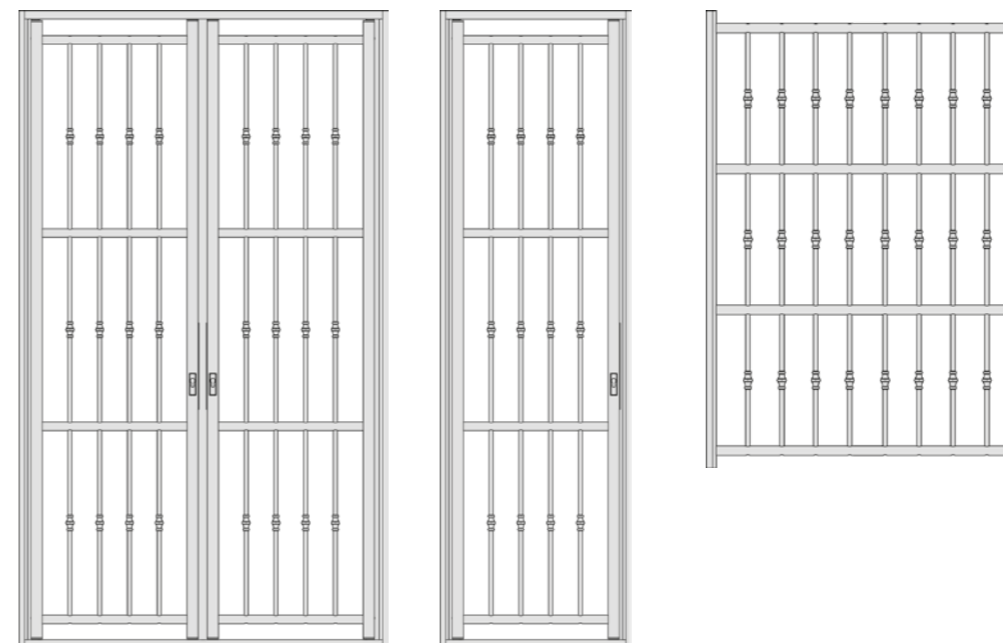
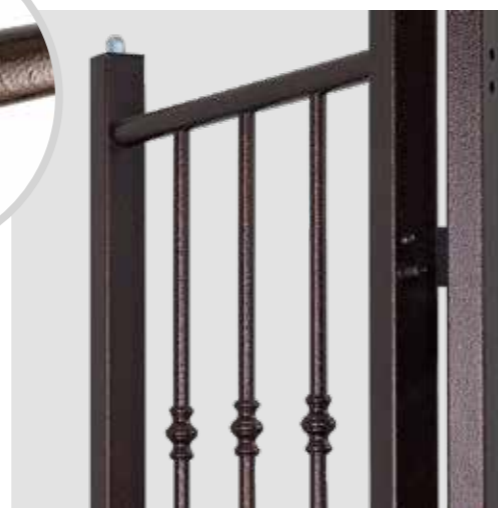

FIGHTER  
F200

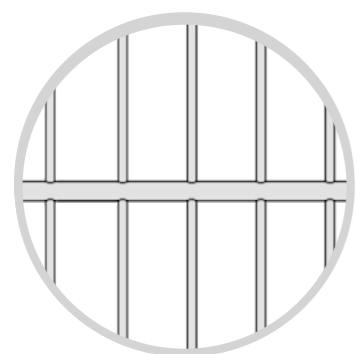

FIGHTER  
F100

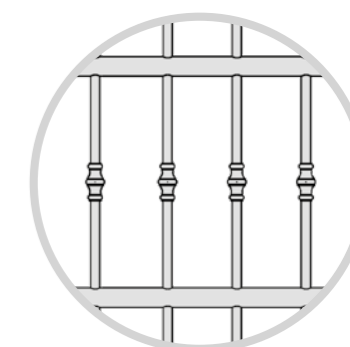
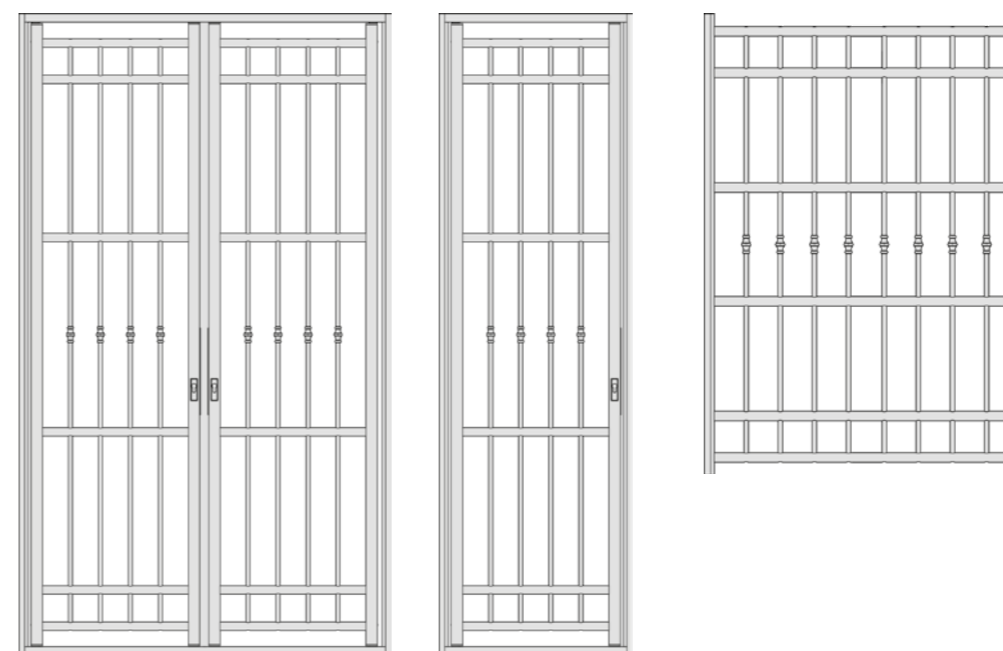
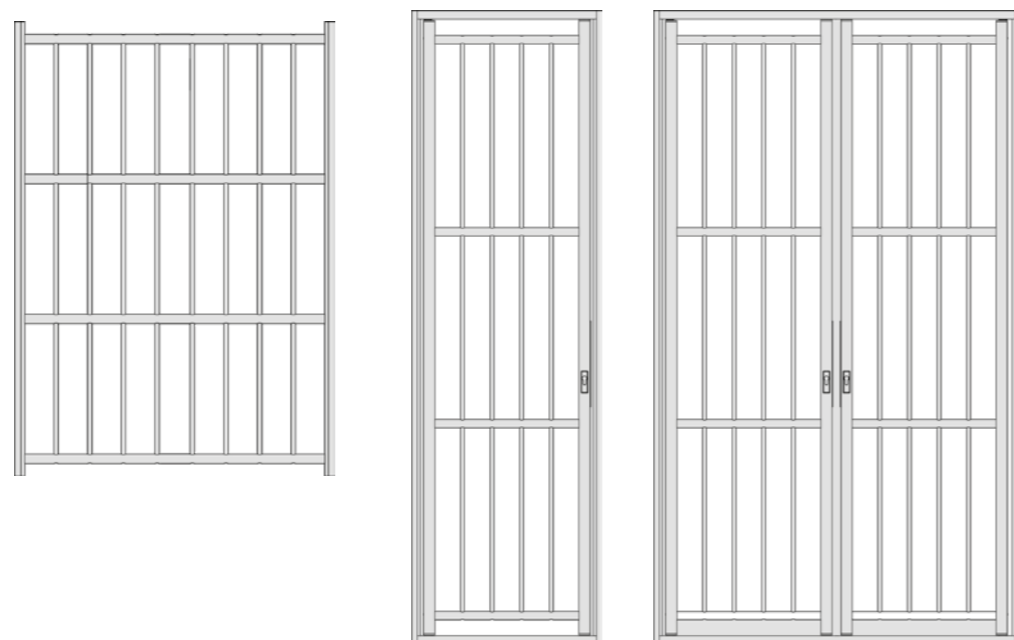

FIGHTER  
F300



# SCHEDA RILIEVO - MISURE GRATE DIMENSIONS SHEET

## APPLICAZIONE CON SORMONTI VERTICALI E TUBOLARI LATERALI AGGIUNTIVI APPLICATION WITH VERTICAL SURFACES AND ADDITIONAL SIDE TUBULARS

Vista da interno / Internal view

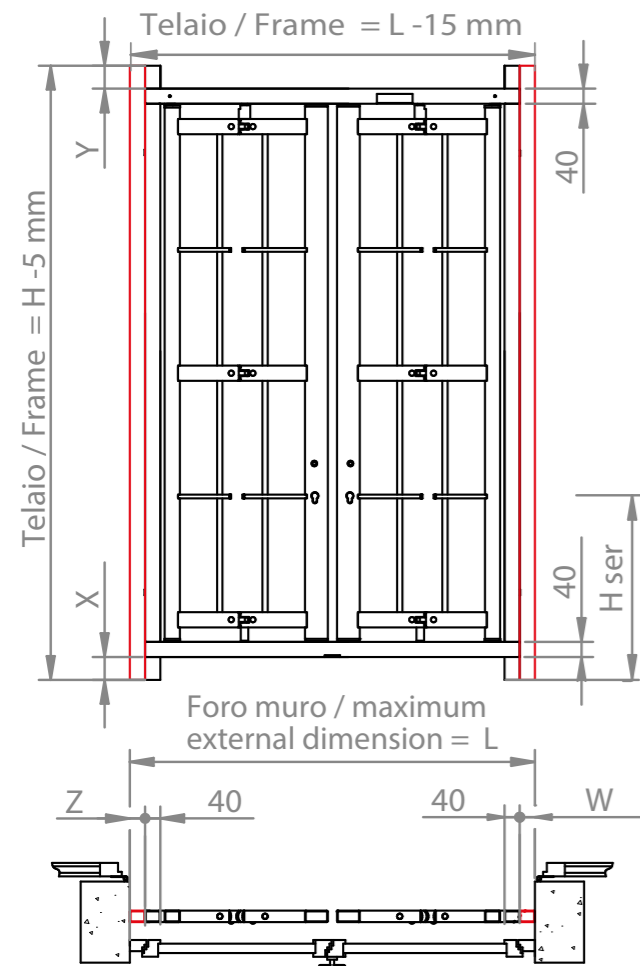

## APPLICAZIONE STANDARD STANDARD APPLICATION

Vista da interno / Internal view

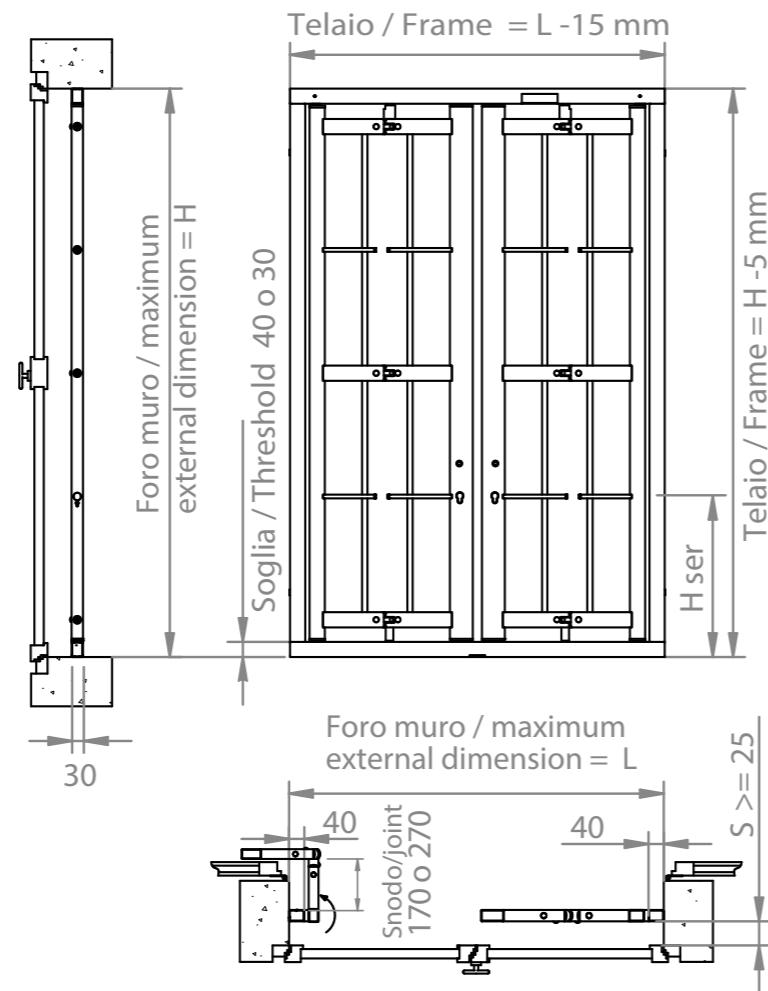

### LEGENDA / LEGEND :

- L:** Luce orizzontale muro/horizontal wall dimension
- H:** Luce verticale muro/vertical wall dimension
- X:** Sormonto telaio inferiore/lower frame overall
- Y:** Sormonto telaio superiore/superior frame overhead
- Z:** Dimensione tubolare aggiuntivo SX/left additional tubular
- W:** Dimensione tubolare aggiuntivo DX/right additional tubular
- S:** Luce minima grata-serramento/minimum dimension grate-window (>= 25 mm)

**N.B.:** in caso di porta finestra verificare se è presente una soglia a terra  
in case of a windowed door, check if equipped with a threshold

## SENSI DI APERTURA OPENING DIRECTIONS

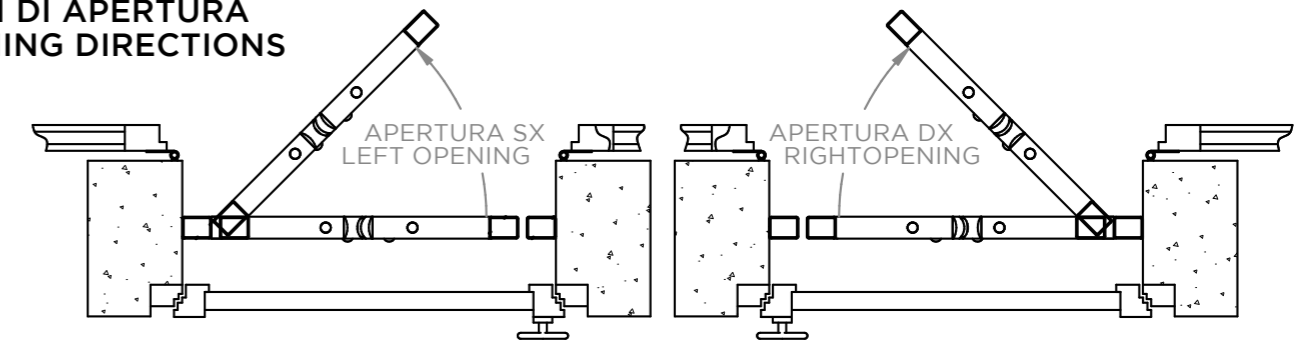

### 1 ANTA 2 SNODI 1 DOOR 2 JOINT

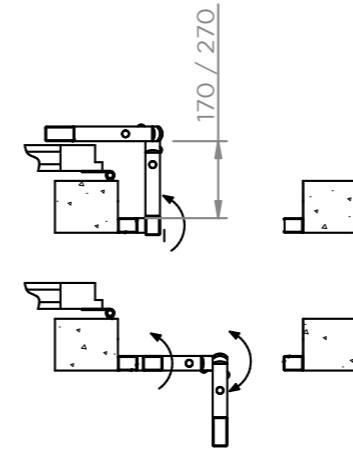

### 1 ANTA 1 SNODO 1 ANTA 1 SNODO

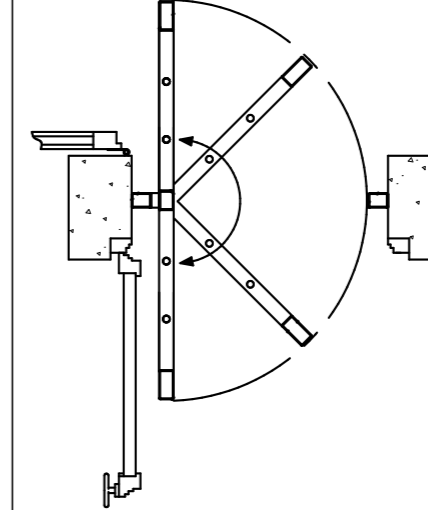

### ANTA FISSA FIXED DOOR

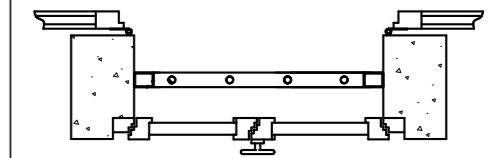

### 2 ANTE 2 SNODI 2 DOOR 2 JOINT

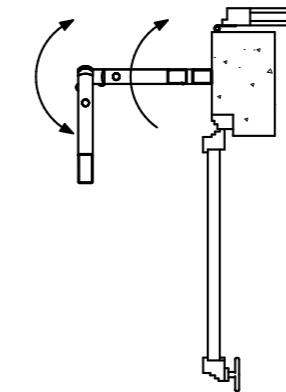
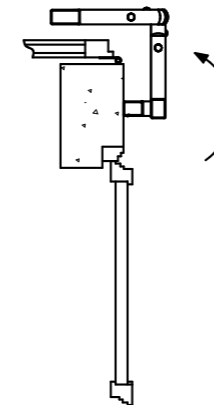

### 2 ANTE 1 SNODO 2 DOOR 1 JOINT

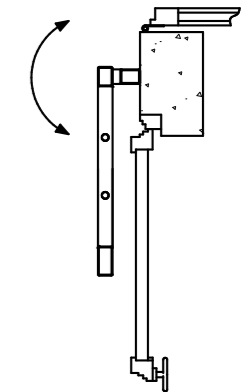
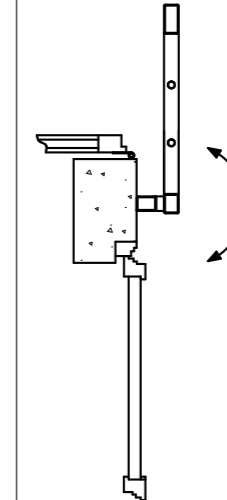

# COLORI E FINITURE DISPONIBILI

Available colors and finishing

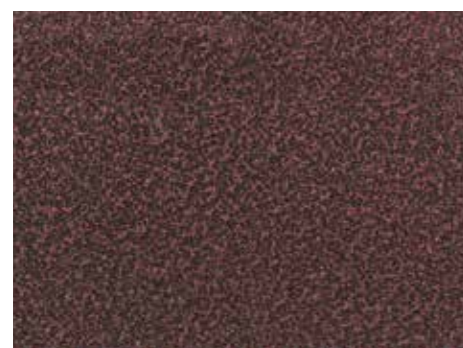

**RAME MARTELLATO  
HAMMERED COPPER**



**MARRONE TESTA DI MORO GRINZ  
GRINZ DARK BROWN**



**RUGGINE  
RUST EFFECT**

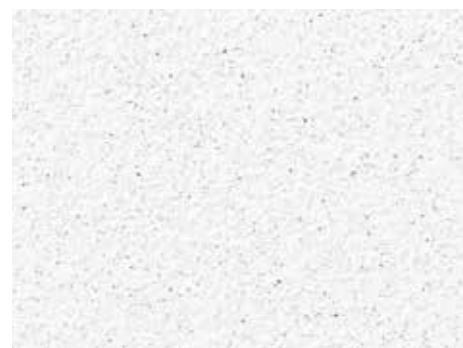

**BIANCO GLITTER  
GLITTERED WHITE**



**GRIGIO GLITTER  
GLITTERED GREY**



**VERDE RAFFAELLO  
GREEN RAFFAELLO**

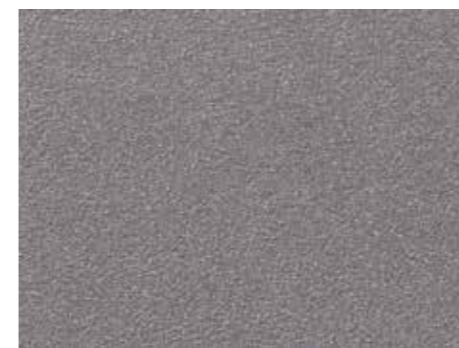

**GRIGIO SABBIA  
GREY SAND**



**MARRONE GLITTER  
GLITTERED BROWN**



**VERDE GLITTER  
GLITTERED GREEN**



**VERDE RAL 6005 GRINZ  
RAL 6005 GRINZ GREEN**

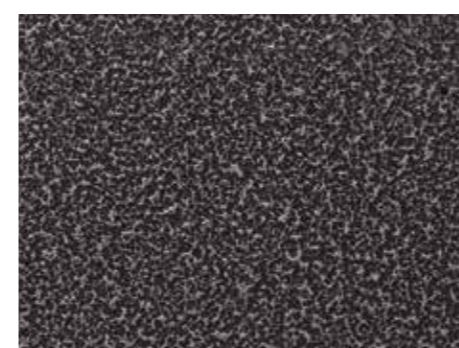

**NERO MARTELLATO  
HAMMERED BLACK**



COLORI RAL



MAZZETTA  
CAMPIONI COLORI  
ED EFFETTI  
SPECIALI  
ALIAS

Color samples  
and special  
effects





**ALIAS** 

DESIGN SECURITY DOORS

LA FORTE IDENTITÀ DI ALIAS, LEADER DI SETTORE SUL TEMA DELLA SICUREZZA DELLE PORTE D'INGRESSO, HA PORTATO L'AZIENDA A ESTENDERE NATURALMENTE LA SUA GRANDE CAPACITÀ DI VISIONE ANCHE ALLA SICUREZZA DI TUTTE LE ALTRE APERTURE ESTERNE DELLA CASA. COME PER LE PORTE D'INGRESSO, ANCHE PER LE GRATE DI SICUREZZA ALIAS SEGUE DA VICINO TUTTE LE FASI DELLA PRODUZIONE: DALLA PROGETTAZIONE - GRAZIE AL DIPARTIMENTO DI RICERCA&SVILUPPO INTERNO ALL'AZIENDA - ALLA LAVORAZIONE DELL'ACCIAIO, ALL'ASSEMBLAGGIO E ALLA VERNICIATURA. QUESTO PER GARANTIRE AL PROCESSO INDUSTRIALE DELLA PRODUZIONE LA MASSIMA QUALITÀ DEL PRODOTTO FINITO, SIA DAL PUNTO DI VISTA TECNICO COSTRUTTIVO CHE ESTETICO.



The strong identity of alias, leader in the security doors sector, has taken the company to naturally extend its view to all the other windows and frames of the house.

As for the entrance doors, also for the safety grates, alias directly follows all the stages of production: from the design - thanks to the research and internal development department - to the steel processing, the assembling and painting. This process ensures the highest quality both from an aesthetic and technical point of view.





# CERTIFICAZIONI Certifications

		DIVISIONE: TESTING-CERTIFICAZIONE DIVISIONE: TESTING & CERTIFICATION		LABORATORIO: Idraulica LABORATORY: Hydraulics	
<b>RAFFORTO DI PROVA</b> <i>(Test Report)</i>					
Pag. 1/20				Pag. 1/20	
N° 0025DCAEF16 Rev. 1				Data: 27/05/2016	
sostituisce il precedente dated 11/03/2016 and its successive amendments					
Serie DEFENDER					
DATI IDENTIFICATIVI DEL CLIENTE: ELEMENT					
ALIAS SRL Via Berlinguer, 22 29020 Settima di Gossolengo (PC)					
NORMA DI RIFERIMENTO: REFERENCE STANDARD					
UNI EN 1627:2011					
DISTRIBUZIONE ESTERNA: EXTERNAL DISTRIBUTION:			DISTRIBUZIONE INTERNA: INTERNAL DISTRIBUTION:		
ALIAS SRL					
SITI DI ACCREDITAMENTO: ACCREDITATION SITES					
		<small>                 IMQ S.p.A.                  Via Salaria, 1000                  00198 Roma (RM)                  Tel. +39 06 52001111 - Fax +39 06 52001112                  www.imq.it             </small>			

		RAFFORTO DI PROVA <i>(Test Report)</i>		Pag. 14/20 Pag. 14/20	
N° 0025DCAEF16 Rev. 1				Data: 27/05/2016	
D) CLASSIFICAZIONE / CLASSIFICATION					
L'insieme dei dati acquisiti nel corso delle prove riportate nel presente rapporto di prova, soddisfa i requisiti di classe <b>3 (3RE)</b> di resistenza all'effrazione secondo la norma UNI EN 1627:2011.					
The whole test values, reported in this test report, meet the requirements for burglar resistance class <b>3 (3RE)</b> according to EN 1627:2011.					
DATA Date		Settore Fisica delle Costruzioni <i>Building Physics Sector</i>		Area Testing <i>Testing Area</i>	
27/05/2016		G. De Napoli		Paolo Fumagalli	
Documento firmato digitalmente ai sensi del D. Lgs. N. 82 del 7 Marzo 2005 e successive modifiche Digitally signed document in accordance with Legislative Decree n. 42 dated March 7 <sup>th</sup> 2005 and subsequent amendments.					
ALLEGATI / ANNEXES					
Allegato / Annex 1: Schema punti di carico / Loading points sketch					
Allegato / Annex 2: Schema punti d'impatto / Impact points sketch					
Allegato / Annex 3: Disegno tecnico / Technical drawing					
		<small>                 IMQ S.p.A.                  Via Salaria, 1000                  00198 Roma (RM)                  Tel. +39 06 52001111 - Fax +39 06 52001112                  www.imq.it             </small>			

		DIVISIONE: TESTING-CERTIFICAZIONE DIVISIONE: TESTING & CERTIFICATION		LABORATORIO: FISICA DELLE COSTRUZIONI LABORATORY: CONSTRUCTION PHYSICS	
<b>RAFFORTO DI PROVA</b> <i>(Test Report)</i>					
Pag. 1/23				Pag. 1/23	
N° 0033DCAEF17				Data: 03/08/2017	
sostituisce il precedente dated 11/03/2016 and its successive amendments					
Grata singola anta mod. FIGHTER <i>Single leaf door grating mod. FIGHTER</i>					
DATI IDENTIFICATIVI DEL CLIENTE: ELEMENT					
ALIAS SRL Via Berlinguer, 22 29020 Settima di Gossolengo (PC)					
NORMA DI RIFERIMENTO: REFERENCE STANDARD					
UNI EN 1627:2011					
DISTRIBUZIONE ESTERNA: EXTERNAL DISTRIBUTION:			DISTRIBUZIONE INTERNA: INTERNAL DISTRIBUTION:		
ALIAS SRL					
SITI DI ACCREDITAMENTO: ACCREDITATION SITES					
		<small>                 IMQ S.p.A.                  Via Salaria, 1000                  00198 Roma (RM)                  Tel. +39 06 52001111 - Fax +39 06 52001112                  www.imq.it             </small>			

		RAFFORTO DI PROVA <i>(Test Report)</i>		Pag. 22/23 Pag. 22/23	
N° 0033DCAEF17				Data: 03/08/2017	
D) CLASSIFICAZIONE / CLASSIFICATION					
L'insieme dei dati acquisiti nel corso delle prove riportate nel presente rapporto di prova, soddisfa i requisiti di classe <b>3 (3RE)</b> di resistenza all'effrazione secondo la norma UNI EN 1627:2011.					
The whole test values, reported in this test report, meet the requirements for burglar resistance class <b>3 (3RE)</b> according to EN 1627:2011.					
DATA Date		Settore Fisica delle Costruzioni <i>Building Physics Sector</i>		Area Testing <i>Testing Area</i>	
03/08/2017		G. De Napoli		Ing. P. Fumagalli	
Documento firmato digitalmente ai sensi del D. Lgs. N. 82 del 7 Marzo 2005 e successive modifiche Digitally signed document in accordance with Legislative Decree n. 42 dated March 7 <sup>th</sup> 2005 and subsequent amendments.					
ALLEGATI / ANNEXES					
Allegato / Annex 1: Schema punti di carico / Loading points sketch					
Allegato / Annex 2: Schema punti d'impatto / Impact points sketch					
		<small>                 IMQ S.p.A.                  Via Salaria, 1000                  00198 Roma (RM)                  Tel. +39 06 52001111 - Fax +39 06 52001112                  www.imq.it             </small>			

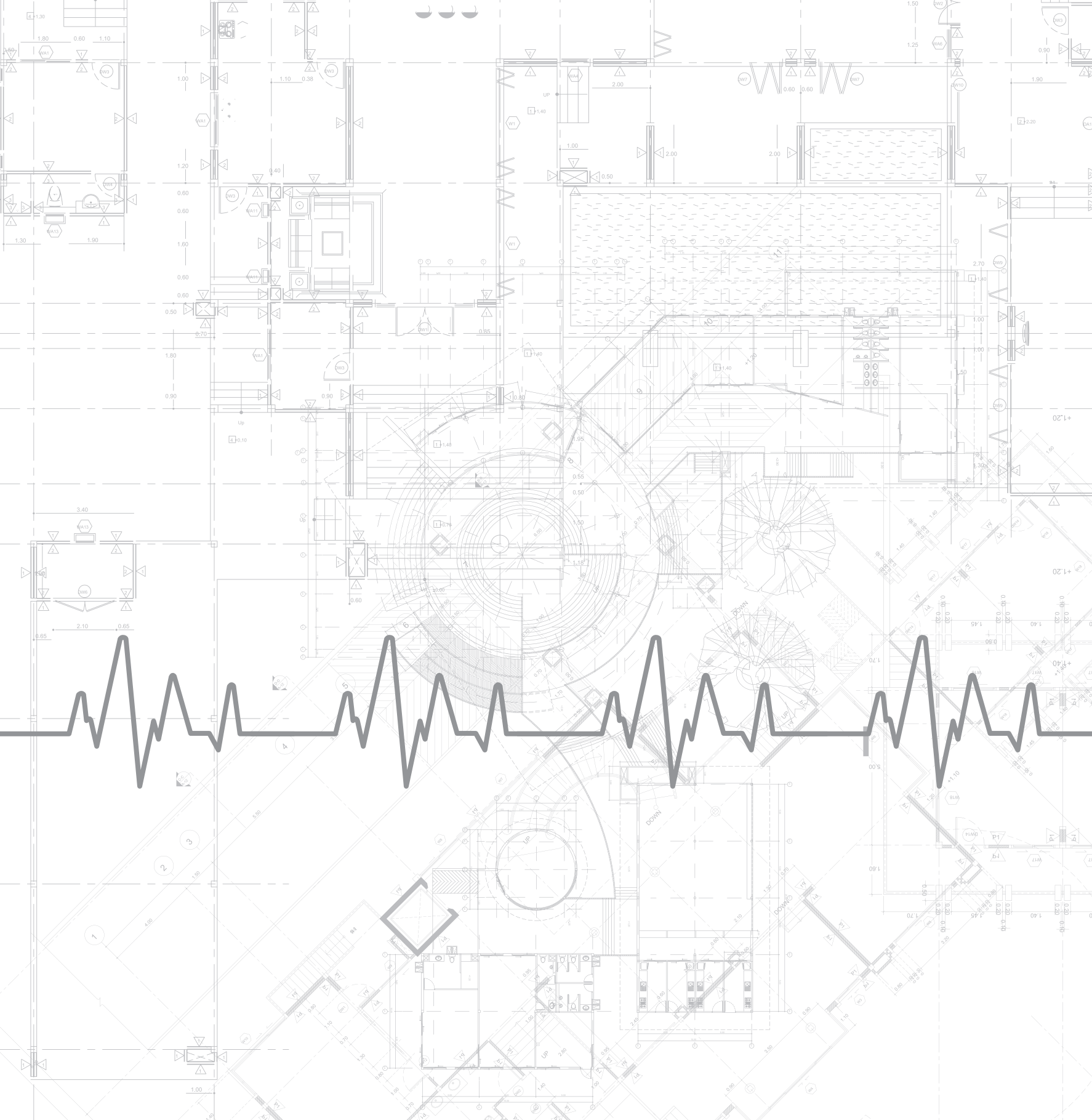

**ALIAS**

**Alias srl**

Via Berlinguer, 22 - Settima 29020 (PC) - Italy

Tel: +39 0523 364040 Fax: +39 0523 364044

Email: [info@aliasblindate.com](mailto:info@aliasblindate.com)

Web e Privacy: [aliasblindate.com](http://aliasblindate.com)